

www.juwel.com



Intelligente Produkte für
Garten und Haushalt



Biostar 2000





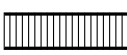

rozměry: ca. 200 x 76 x v 52/44 cm • Art.-Nr.20148

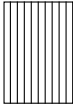
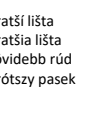
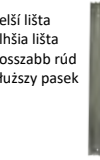





Návod na montáž / Návod na montáž
Szerelési útmutató / instrukcje składania



Obsah balení / obsah balenia / Csomag tartalma / Zawartość Paczki

A	B	C	D	E	F	G
					 kratší lišta kratšia lišta rövidebb rúd krótszy pasek	 delší lišta dlhšia lišta hosszabb rúd dłuższy pasek
~ 970 x 480 mm	~ 970 x 400 mm	~ 705 x 485/410 mm	~ 705 x 485/410 mm	~ 739 x 485 mm	Aluminium ~ 382 mm	Aluminium ~ 459 mm
2 x	2 x	1 x	1 x	4 x	2 x	2 x
52597	52596	52591	52592	52595	52398	52396



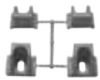



H	I	J	K	L	M	N
	 SW Aluminium ~ 664 mm	 OUT IN SW Aluminium ~ 705 mm		 ~ 980 x 765 mm		 ~ 1400 mm
1 x	2 x	2 x	8 x	2 x	2 x	2 x
25938	52293	52782	25939	52204	26782	36684

O	P	Q	R	S	T	U
						
4 x	4 x	4 x	2 x	12 x	12 x	1 x
25936	26545	26808	25937	26398	26399	25940

**Nutné náradí / nutné náradie / Szükséges
eszközök / Niezbędne narzędzia**



Obsah balení / obsah balenia / Csomag tartalma / Zawartość Paczki

V	W	X	Y	Z	a	b
						
Aluminium ~ 459 mm	Aluminium ~ 382 mm				Aluminium ~ 713 mm	
1 x	1 x	2 x	4 x	4 x	2 x	4 x
52395	52394	25890	25792	33523	22790	26641



PařeniřtĚ pevnĚ pŕipevňete k zemi, silný vĕtr by mohl zpŕosobit řkody.

Parenisko pevne pŕipevnite k zemi, silný vietor by mohol spŕosobiť řkody.

Erŕsen rŕgztĭte a melegĕgyat a talajra, az erŕs szĕl kĕrokat okozhat.

Przymocuj inspekt mocno do ziemi, silny wiatr może spowodowaĕ uszkodzenia.

D Vor dem Aufbau Anleitung lesen und für spätere Verwendung aufbewahren.

GB Before assembly, please read the instructions and then keep them for further reference.

F Avant le montage, veuillez lire la présente notice et la ranger soigneusement afin de pouvoir la réutiliser ultérieurement.

NL Vŕŕr montage a.u.b. de handleiding doorlezen en voor later gebruik bewaren!

I Prima del montaggio, leggere le istruzioni e conservarle per un utilizzo successivo.

E Antes del montaje deberĕn leerse las instrucciones y guardarlas para un uso posterior.

SF Lue kĕyttŕŕhje huolellisesti lĕpi ennen asennusta ja sĕilytĕ se vastaisuuden varalta.

S Lĕs igenom instruktionerna fŕre montering och spara dem fŕre anvĕndning vid ett senare tillfĕlle.

DK Vejledning skal lĕses inden pobygning og gemmes til senere brug.

N Les bruksanvisningen fŕre montering og oppbevar den for senere bruk.

HR Pŕije sastavljanja pŕoĕitati uputstvo i saĕuvati ga za kasnije koriřtenje.

SI Pred postavitvijo natanĕno preberite navodila ter jih shranite za kasnejšo uporabo.

SK Pred postavenĕm si pŕeĕtajte nĕvod a odloĕte si ho na neskorřie pouĕitie.

CZ Pŕed montĕĕzi si pŕeĕtĕte nĕvod a uschovejte jej pro pozdĕřři pouĕitie.

BH Pŕije sastavljanja pŕoĕitati uputstvo i saĕuvati ga za kasnije koriřtenje.

PL Przeczytaĕ przed montaĕem i zachowaĕ do pŕŕnieszego wykorzystania.

HU Az ŕsszeszerelĕs elŕtt olvassa el az ŕtmutatŕt, ĕs ŕrize meg a kĕsŕbbi hasznĕlathoz.

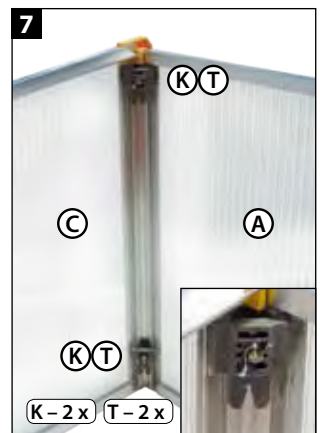
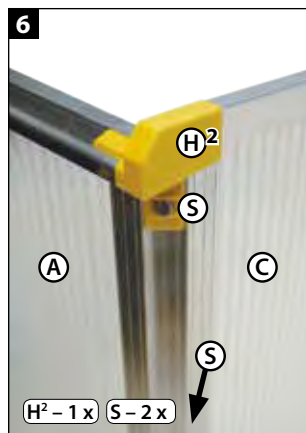
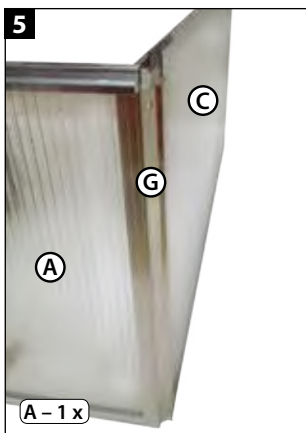
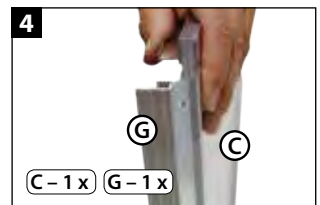
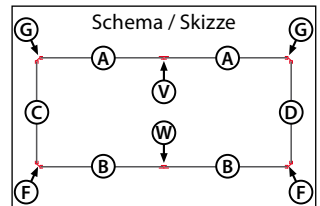
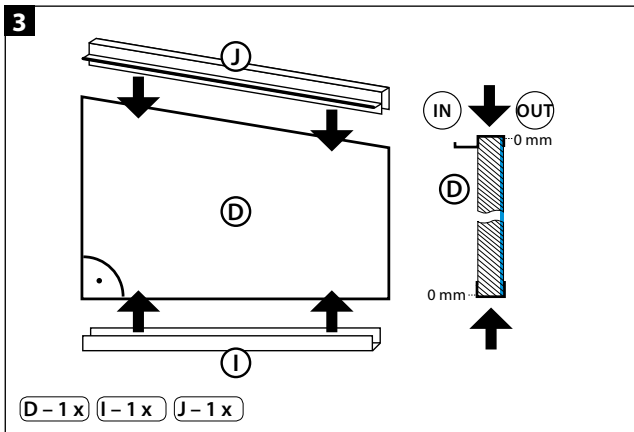
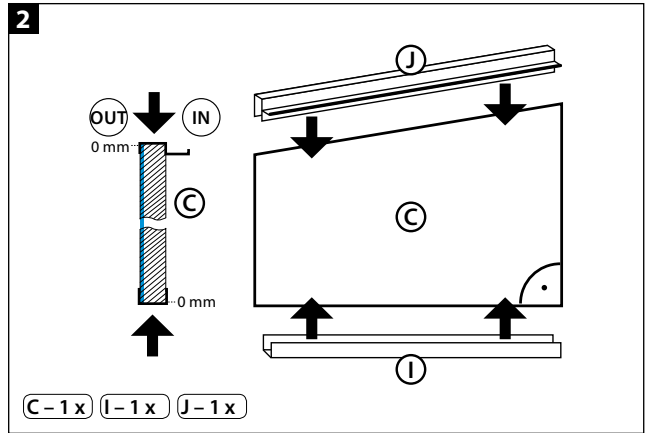
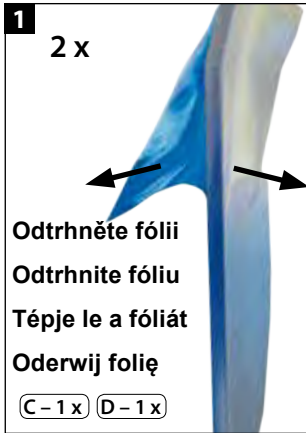

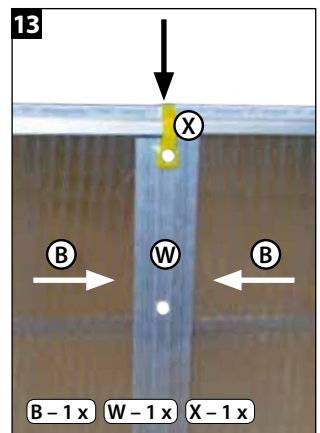
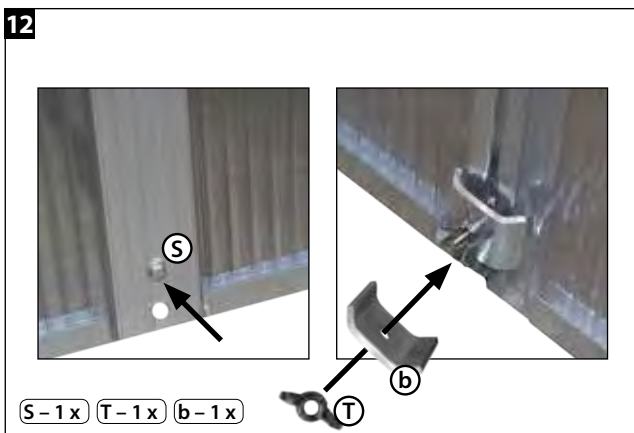
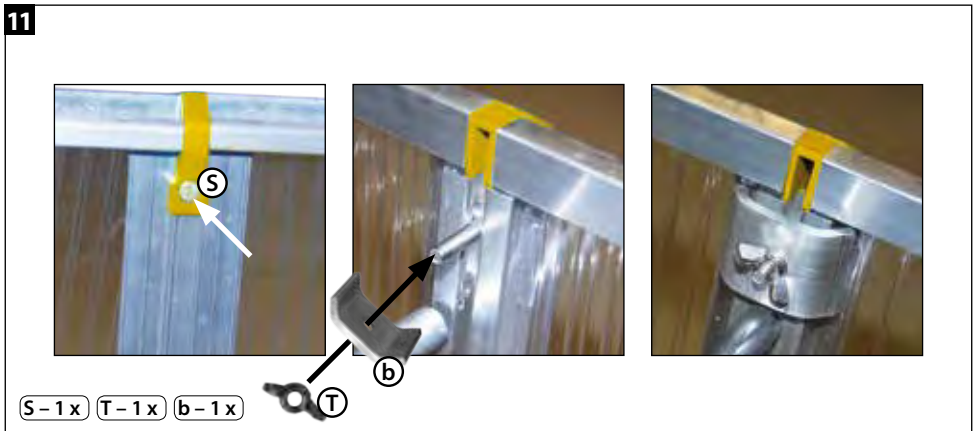
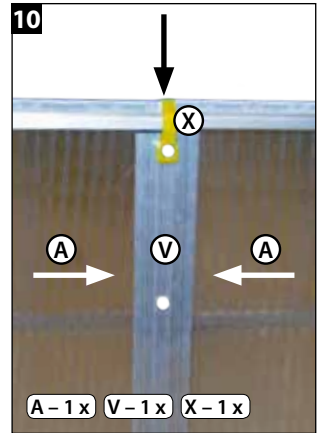
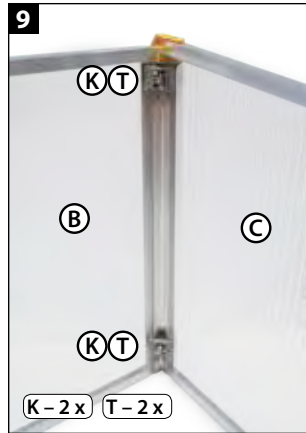
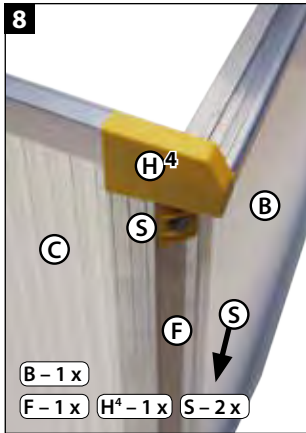

14

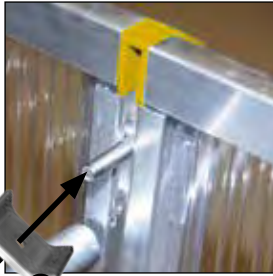
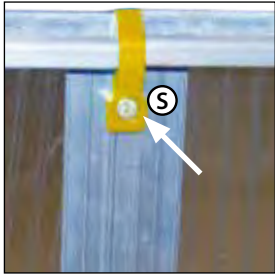

S-1x T-1x b-1x



15

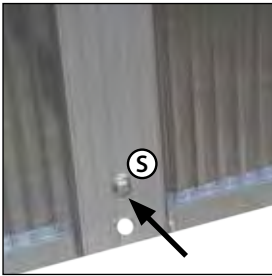

S-1x T-1x b-1x



16

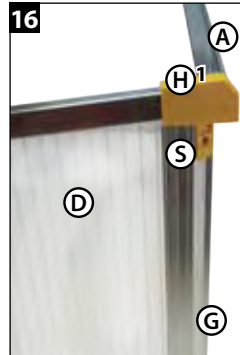

D-1x
G-1x H¹-1x S-2x

17

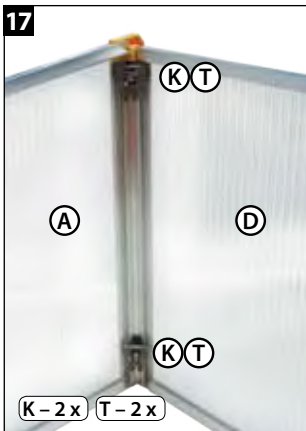

K-2x T-2x

18

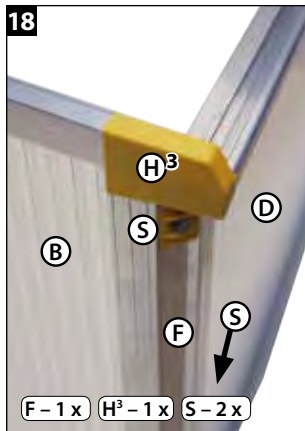

F-1x H³-1x S-2x

19

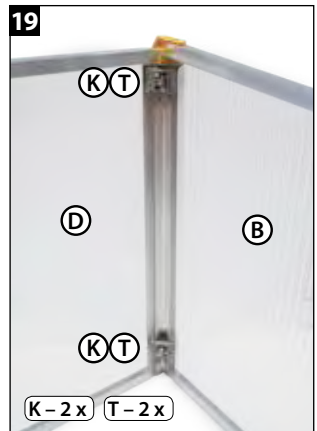

K-2x T-2x

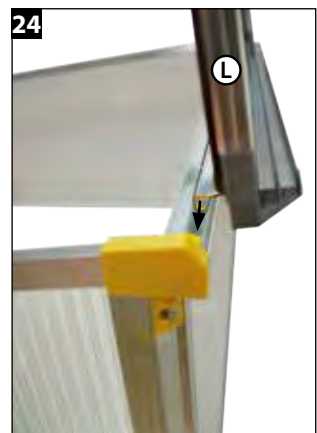
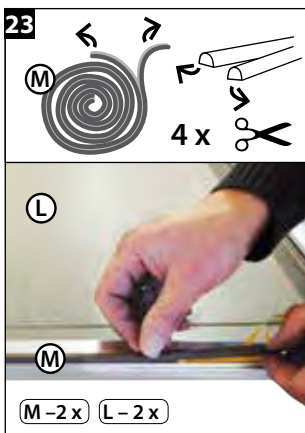
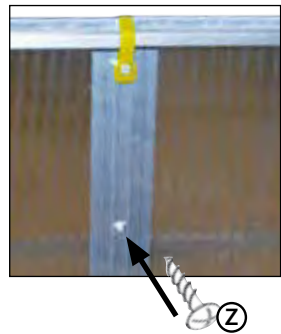
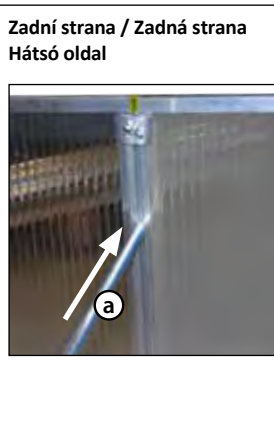
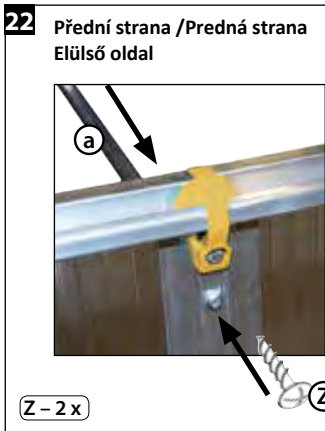
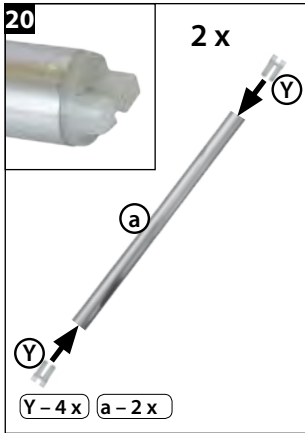

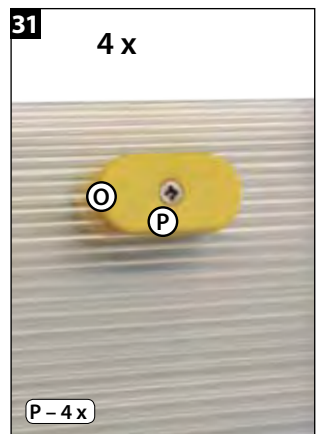
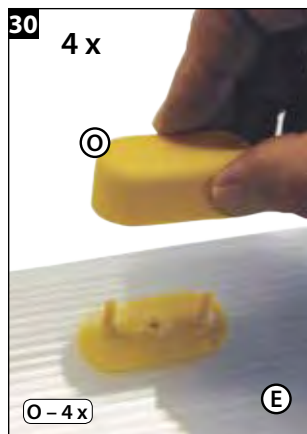
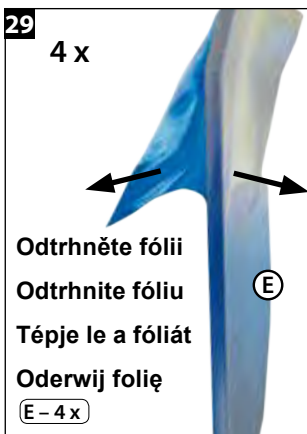
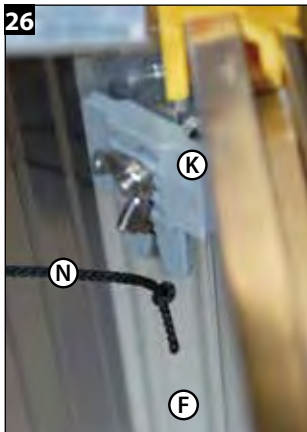
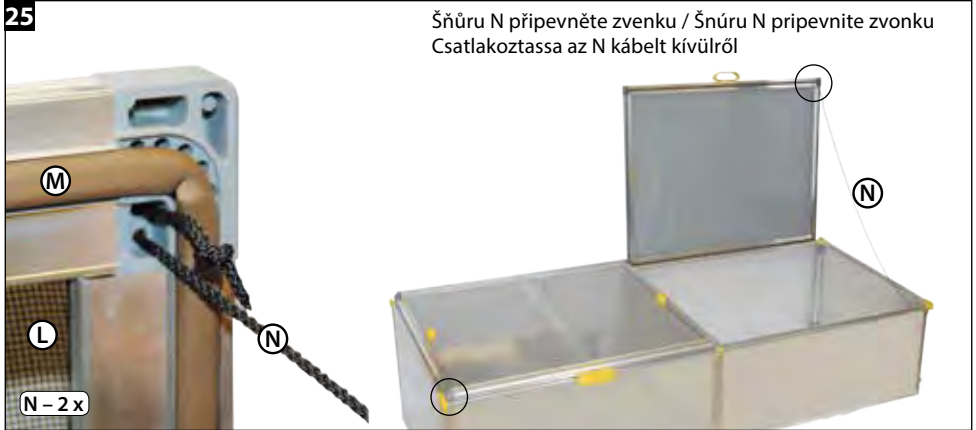

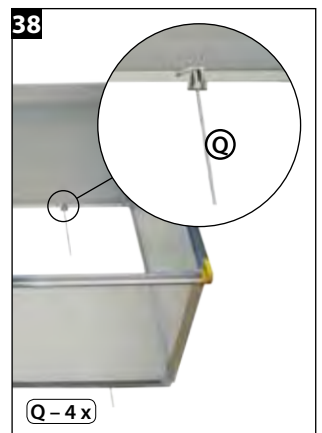
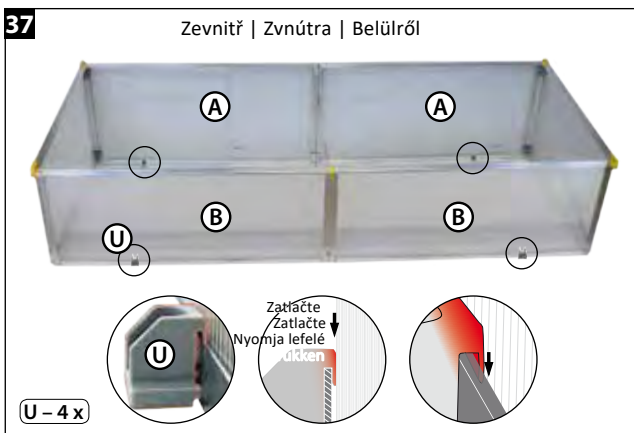
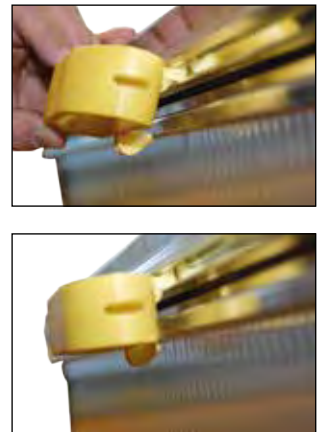
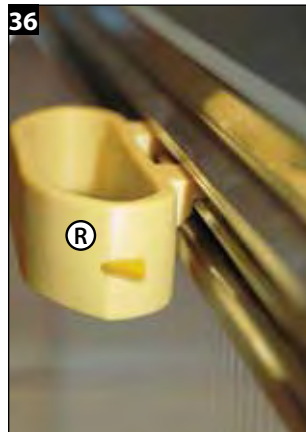
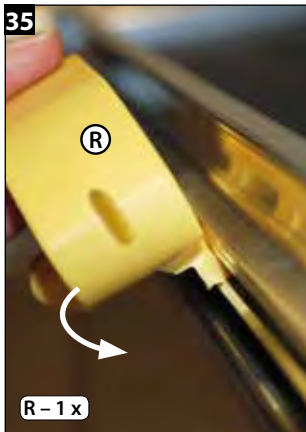
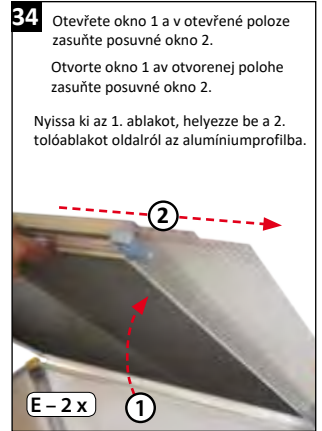
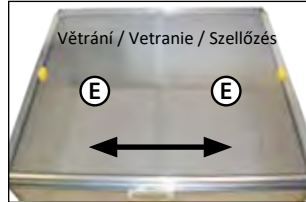
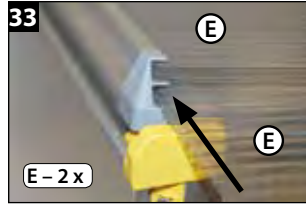

**Ende der Montageanleitung
Ganzjahres-Beetsystem BIOSTAR PROTECT 2000**

Bitte die Sicherheitshinweise lesen und beachten!

Siehe ab Seite 3 von der Montageanleitung für
Ganzjahres-Beetsystem BIOSTAR PROTECT 1000.

Dazu bitte das Heft drehen



**Ende der Montageanleitung
Ganzjahres-Beetsystem BIOSTAR PROTECT 1000**